

CORREAS DE TIEMPO

Las tres dimensiones principales que forman la referencia de una correa dentada de tiempo son:

Longitud - Paso - Ancho

Longitud

Es el largo de la correa (circunferencia) tomado en pulgadas sobre la línea del paso por donde corren sus cuerdas de tensión.

Ejemplo: **800 H 150**

→ longitud
80 pulgadas

Paso

Es la distancia en pulgadas existente entre un diente y el siguiente. Son cinco pasos y a cada uno le corresponde una letra para su referencia así:

PASO	LETRA
1/5"	XL
3/8"	L
1/2"	H
7/8"	XH
1- 1/4"	XXH

Ejemplo: **800 H 150**

→ paso 1/2"

Ancho

Se mide en pulgadas y se expresa al final de la referencia.

Ejemplo: **800 H 150**

→ ancho 1,5 pulgadas

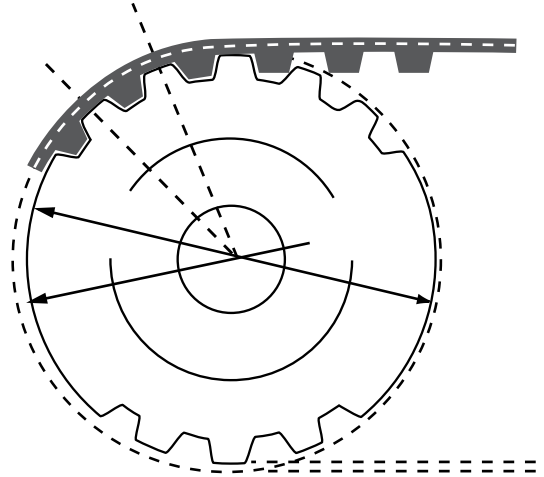

1/5 PASO "EXTRA - LIGERO" (XL)



3/8 PASO "LIGERO" (L)



1/2 PASO "PESADO" (H)



7/8 "EXTRA - PESADO" (XH)



1-1/4 PASO DOBLE "EXTRA - PESADO" (XXH)

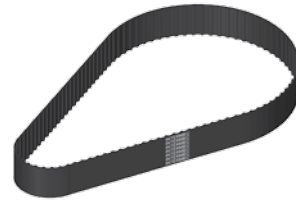
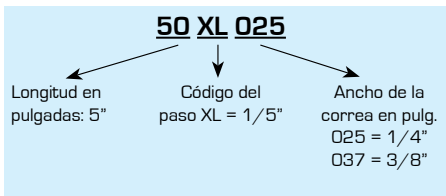

SECCION DE CORREAS A TAMAÑO NATURAL

SIGNIFICADO DE LA REFERENCIA

1/5 PASO "EXTRA - LIGERO" (XL)

CORREAS XL (PASO 1/5")

Referencia	No. de Dientes	Longitud (Pulgadas)
50XL025	25	5,0
50XL037	25	5,0
60XL025	30	6,0
60XL037	30	6,0
70XL025	35	7,0
70XL037	35	7,0
80XL025	40	8,0
80XL037	40	8,0
90XL025	45	9,0
90XL037	45	9,0
100XL025	50	10,0
100XL037	50	10,0
110XL025	55	11,0
110XL037	55	11,0
120XL025	60	12,0
120XL037	60	12,0
130XL025	65	13,0
130XL037	65	13,0
140XL025	70	14,0
140XL037	70	14,0
150XL025	75	15,0
150XL037	75	15,0
160XL025	80	16,0
160XL037	80	16,0
170XL025	85	17,0
170XL037	85	17,0
180XL025	90	18,0
180XL037	90	18,0
190XL025	95	19,0
190XL037	95	19,0
200XL025	100	20,0
200XL037	100	20,0
210XL025	105	21,0
210XL037	105	21,0
220XL025	110	22,0
220XL037	110	22,0
230XL025	115	23,0
230XL037	115	23,0
240XL025	120	24,0
240XL037	120	24,0
250XL025	125	25,0

CORREAS XL (PASO 1/5")

Referencia	No. de Dientes	Longitud (Pulgadas)
250XL037	125	25,0
260XL025	130	26,0
260XL037	130	26,0
280XL025	140	28,0
280XL037	140	28,0
290XL025	145	29,0
290XL037	145	29,0
300XL025	150	30,0
300XL037	150	30,0
310XL025	155	31,0
310XL037	155	31,0
330XL025	165	33,0
330XL037	165	33,0
340XL025	170	34,0
340XL037	170	34,0
350XL025	175	35,0
350XL037	175	35,0
370XL025	185	37,0
370XL037	185	37,0
380XL025	190	38,0
380XL037	190	38,0
390XL025	195	39,0
390XL037	195	39,0
400XL025	200	40,0
400XL037	200	40,0
420XL025	210	42,0
420XL037	210	42,0
450XL025	225	45,0
450XL037	225	45,0
460XL025	230	46,0
460XL037	230	46,0
480XL025	240	48,0
480XL037	240	48,0
500XL025	250	50,0
500XL037	250	50,0
570XL025	285	57,0
570XL037	285	57,0
630XL025	315	63,0
630XL037	315	63,0
770XL025	385	77,0
770XL037	385	77,0

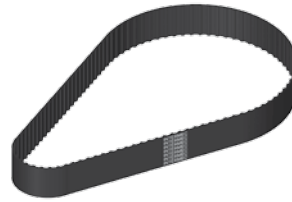
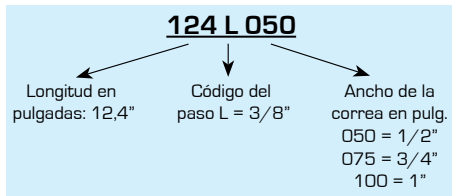
SIGNIFICADO DE LA REFERENCIA

3/8 PASO "LIGERO" (L)

CORREAS L (PASO 3/8")

Referencia	No. de Dientes	Longitud (Pulgadas)
124L050	33	12,4
124L075	33	12,4
124L100	33	12,4
135L050	36	13,5
135L075	36	13,5
135L100	36	13,5
150L050	40	15,0
150L075	40	15,0
150L100	40	15,0
165L050	44	16,5
165L075	44	16,5
165L100	44	16,5
187L050	50	18,8
187L075	50	18,8
187L100	50	18,8
195L050	52	19,5
195L075	52	19,5
195L100	52	19,5
210L050	56	21,0
210L075	56	21,0
210L100	56	21,0
225L050	60	22,5
225L075	60	22,5
225L100	60	22,5
240L050	64	24,0
240L075	64	24,0
240L100	64	24,0
255L050	68	25,5
255L075	68	25,5
255L100	68	25,5
270L050	72	27,0
270L075	72	27,0
270L100	72	27,0
285L050	76	28,5
285L075	76	28,5
285L100	76	28,5
300L050	80	30,0
300L075	80	30,0
300L100	80	30,0
315L050	84	31,5
315L075	84	31,5

CORREAS L (PASO 3/8")

Referencia	No. de Dientes	Longitud (Pulgadas)
315L100	84	31,5
322L050	86	32,3
322L075	86	32,3
322L100	86	32,3
345L050	92	34,5
345L075	92	34,5
345L100	92	34,5
367L050	98	36,8
367L075	98	36,8
367L100	98	36,8
390L050	104	39,0
390L075	104	39,0
390L100	104	39,0
420L050	112	42,0
420L075	112	42,0
420L100	112	42,0
450L050	120	45,0
450L075	120	45,0
450L100	120	45,0
480L050	128	48,0
480L075	128	48,0
480L100	128	48,0
510L050	136	51,0
510L075	136	51,0
510L100	136	51,0
540L050	144	54,0
540L075	144	54,0
540L100	144	54,0
600L050	160	60,0
600L075	160	60,0
600L100	160	60,0
660L050	176	66,0
660L075	176	66,0
660L100	176	66,0
817L050	218	81,8
817L075	218	81,8
817L100	218	81,8
900L050	240	90,0
900L075	240	90,0
900L100	240	90,0

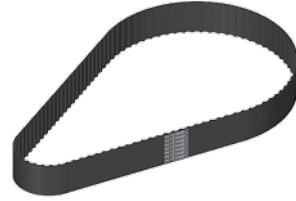
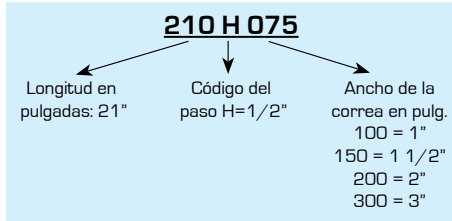
SIGNIFICADO DE LA REFERENCIA

1/2 PASO "PESADO" (H)

CORREAS H (PASO 1/2")

Referencia	No. de Dientes	Longitud (Pulgadas)
210H075	42	21,0
210H100	42	21,0
210H150	42	21,0
210H200	42	21,0
210H300	42	21,0
220H075	44	22,0
220H100	44	22,0
220H150	44	22,0
220H200	44	22,0
220H300	44	22,0
230H075	46	23,0
230H100	46	23,0
230H150	46	23,0
230H200	46	23,0
230H300	46	23,0
240H075	48	24,0
240H100	48	24,0
240H150	48	24,0
240H200	48	24,0
240H300	48	24,0
270H075	54	27,0
270H100	54	27,0
270H150	54	27,0
270H200	54	27,0
270H300	54	27,0
300H075	60	30,0
300H100	60	30,0
300H150	60	30,0
300H200	60	30,0
300H300	60	30,0
320H075	64	32,0
320H100	64	32,0
320H150	64	32,0
320H200	64	32,0
320H300	64	32,0
330H075	66	33,0
330H100	66	33,0
330H150	66	33,0
330H200	66	33,0
330H300	66	33,0

CORREAS H (PASO 1/2")

Referencia	No. de Dientes	Longitud (Pulgadas)
340H075	68	34,0
340H100	68	34,0
340H150	68	34,0
340H200	68	34,0
340H300	68	34,0
350H075	70	35,0
350H100	70	35,0
350H150	70	35,0
350H200	70	35,0
350H300	70	35,0
360H075	72	36,0
360H100	72	36,0
360H150	72	36,0
360H200	72	36,0
360H300	72	36,0
370H075	74	37,0
370H100	74	37,0
370H150	74	37,0
370H200	74	37,0
370H300	74	37,0
390H075	78	39,0
390H100	78	39,0
390H150	78	39,0
390H200	78	39,0
390H300	78	39,0
400H075	80	40,0
400H100	80	40,0
400H150	80	40,0
400H200	80	40,0
400H300	80	40,0
410H075	82	41,0
410H100	82	41,0
410H150	82	41,0
410H200	82	41,0
410H300	82	41,0
420H075	84	42,0
420H100	84	42,0
420H150	84	42,0
420H200	84	42,0
420H300	84	42,0

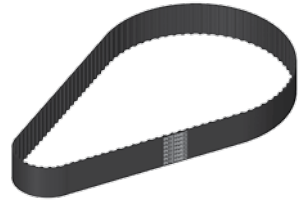
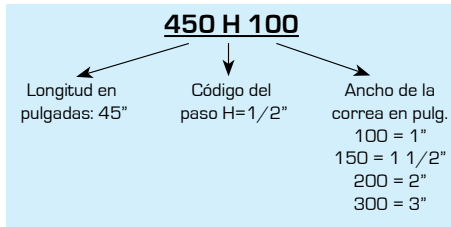
SIGNIFICADO DE LA REFERENCIA

1/2 PASO "PESADO" (H)

CORREAS H (PASO 1/2")

Referencia	No. de Dientes	Longitud (Pulgadas)
450H075	90	45,0
450H100	90	45,0
450H150	90	45,0
450H200	90	45,0
450H300	90	45,0
480H075	96	48,0
480H100	96	48,0
480H150	96	48,0
480H200	96	48,0
480H300	96	48,0
490H075	98	49,0
490H100	98	49,0
490H150	98	49,0
490H200	98	49,0
490H300	98	49,0
510H075	102	51,0
510H100	102	51,0
510H150	102	51,0
510H200	102	51,0
510H300	102	51,0
540H075	108	54,0
540H100	108	54,0
540H150	108	54,0
540H200	108	54,0
540H300	108	54,0
560H075	112	56,0
560H100	112	56,0
560H150	112	56,0
560H200	112	56,0
560H300	112	56,0
570H075	114	57,0
570H100	114	57,0
570H150	114	57,0
570H200	114	57,0
570H300	114	57,0
585H075	117	58,5
585H100	117	58,5
585H150	117	58,5
585H200	117	58,5
585H300	117	58,5

CORREAS H (PASO 1/2")

Referencia	No. de Dientes	Longitud (Pulgadas)
600H075	120	60,0
600H100	120	60,0
600H150	120	60,0
600H200	120	60,0
600H300	120	60,0
630H075	126	63,0
630H100	126	63,0
630H150	126	63,0
630H200	126	63,0
630H300	126	63,0
645H075	129	64,5
645H100	129	64,5
645H150	129	64,5
645H200	129	64,5
645H300	129	64,5
660H075	132	66,0
660H100	132	66,0
660H150	132	66,0
660H200	132	66,0
660H300	132	66,0
700H075	140	70,0
700H100	140	70,0
700H150	140	70,0
700H200	140	70,0
700H300	140	70,0
730H075	146	73,0
730H100	146	73,0
730H150	146	73,0
730H200	146	73,0
730H300	146	73,0
750H075	150	75,0
750H100	150	75,0
750H150	150	75,0
750H200	150	75,0
750H300	150	75,0
780H075	156	78,0
780H100	156	78,0
780H150	156	78,0
780H200	156	78,0
780H300	156	78,0

SIGNIFICADO DE LA REFERENCIA

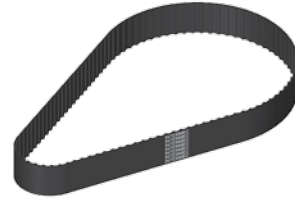
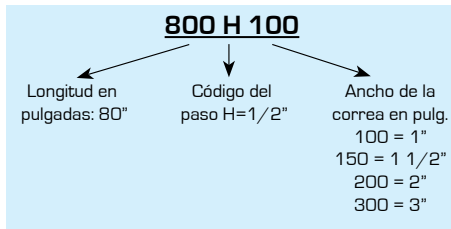

1/2 PASO "PESADO" (H)



CORREAS H (PASO 1/2")

Referencia	No. de Dientes	Longitud (Pulgadas)
800H075	160	80,0
800H100	160	80,0
800H150	160	80,0
800H200	160	80,0
800H300	160	80,0
820H075	164	82,0
820H100	164	82,0
820H150	164	82,0
820H200	164	82,0
820H300	164	82,0
840H075	168	84,0
840H100	168	84,0
840H150	168	84,0
840H200	168	84,0
840H300	168	84,0
850H075	170	85,0
850H100	170	85,0
850H150	170	85,0
850H200	170	85,0
850H300	170	85,0
900H075	180	90,0
900H100	180	90,0
900H150	180	90,0
900H200	180	90,0
900H300	180	90,0
960H075	192	96,0
960H100	192	96,0
960H150	192	96,0
960H200	192	96,0
960H300	192	96,0
1000H075	200	100,0
1000H100	200	100,0
1000H150	200	100,0
1000H200	200	100,0

CORREAS H (PASO 1/2")

Referencia	No. de Dientes	Longitud (Pulgadas)
1000H300	200	100,0
1100H075	220	110,0
1100H100	220	110,0
1100H150	220	110,0
1100H200	220	110,0
1100H300	220	110,0
1140H075	228	114,0
1140H100	228	114,0
1140H150	228	114,0
1140H200	228	114,0
1140H300	228	114,0
1250H075	250	125,0
1250H100	250	125,0
1250H150	250	125,0
1250H200	250	125,0
1250H300	250	125,0
1400H075	280	140,0
1400H100	280	140,0
1400H150	280	140,0
1400H200	280	140,0
1400H300	280	140,0
1550H075	310	155,0
1550H100	310	155,0
1550H150	310	155,0
1550H200	310	155,0
1550H300	310	155,0
1700H075	340	170,0
1700H100	340	170,0
1700H150	340	170,0
1700H200	340	170,0
1700H300	340	170,0

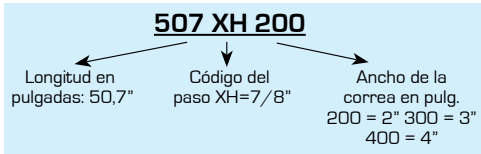
SIGNIFICADO DE LA REFERENCIA

CORREAS XH (PASO 7/8")

Referencia	No. de Dientes	Longitud (Pulgadas)
507XH200	58	50,8
507XH300	58	50,8
507XH400	58	50,8
560XH200	64	56,0
560XH300	64	56,0
560XH400	64	56,0
630XH200	72	63,0
630XH300	72	63,0
630XH400	72	63,0
700XH200	80	70,0
700XH300	80	70,0
700XH400	80	70,0
770XH200	88	77,0
770XH300	88	77,0
770XH400	88	77,0
840XH200	96	84,0
840XH300	96	84,0
840XH400	96	84,0

7/8 " EXTRA - PESADO" (XH)

CORREAS XH (PASO 7/8")

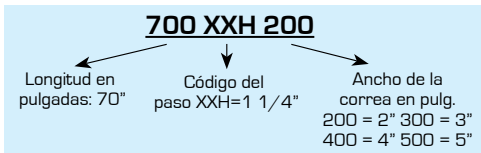
Referencia	No. De Dientes	Longitud (Pulgadas)
980XH200	112	98,0
980XH300	112	98,0
980XH400	112	98,0
1120XH200	128	112,0
1120XH300	128	112,0
1120XH400	128	112,0
1260XH200	144	126,0
1260XH300	144	126,0
1260XH400	144	126,0
1400XH200	160	140,0
1400XH300	160	140,0
1400XH400	160	140,0
1540XH200	176	154,0
1540XH300	176	154,0
1540XH400	176	154,0
1750XH200	200	175,0
1750XH300	200	175,0
1750XH400	200	175,0

SIGNIFICADO DE LA REFERENCIA

CORREAS XXH (PASO 1 1/4")

Referencia	No. de Dientes	Longitud (Pulgadas)
700XXH200	56	70,0
700XXH300	56	70,0
700XXH400	56	70,0
700XXH500	56	70,0
800XXH200	64	80,0
800XXH300	64	80,0
800XXH400	64	80,0
800XXH500	64	80,0
900XXH200	72	90,0
900XXH300	72	90,0
900XXH400	72	90,0
900XXH500	72	90,0
1000XXH200	80	100,0
1000XXH300	80	100,0
1000XXH400	80	100,0
1000XXH500	80	100,0

1-1/4 PASO DOBLE "EXTRA - PESADO"

CORREAS XXH (PASO 1 1/4")

Referencia	No. De Dientes	Longitud (Pulgadas)
1200XXH200	96	120,0
1200XXH300	96	120,0
1200XXH400	96	120,0
1200XXH500	96	120,0
1400XXH200	112	140,0
1400XXH300	112	140,0
1400XXH400	112	140,0
1400XXH500	112	140,0
1600XXH200	128	160,0
1600XXH300	128	160,0
1600XXH400	128	160,0
1600XXH500	128	160,0
1800XXH200	144	180,0
1800XXH300	144	180,0
1800XXH400	144	180,0
1800XXH500	144	180,0